

## Analysis of the use of photovoltaic panels on the roof and walls of passenger carriages to reduce electricity consumption

Piotr Stegenta<sup>a,\*</sup> , Paweł Daszkiewicz<sup>b</sup> , Mariusz Far<sup>a</sup> 

<sup>a</sup> PKP Intercity Remtrak Sp. z o.o., Poznan, Poland

<sup>b</sup> Poznan University of Technology, Faculty of Civil and Transport Engineering, Poznan, Poland

### ARTICLE INFO

Received: 25 October 2024  
Revised: 6 December 2024  
Accepted: 12 December 2024  
Available online: 7 January 2025

### KEYWORDS

renewable energy  
solar energy  
photovoltaic cells  
solar panels  
passenger carriages

*The article discusses the possibility of using solar panels on passenger rail carriages to reduce electrical energy consumption. In the first part of the paper, the possibility of using solar energy under Polish location conditions is discussed and the general parameters of selected solar panels are presented. In the following sections, the possibility of installing solar panels on a railway carriage is analysed. A theoretical evaluation of the energy gain per year and per months is also carried out, taking into account power losses. Finally, the topology of photovoltaic networks is outlined, including the choice of energy storage.*

This is an open access article under the CC BY license (<http://creativecommons.org/licenses/by/4.0/>)

## 1. Introduction

The popularity of photovoltaic panels in Poland is steadily increasing year on year. They are becoming more widely installed on the roofs of residential buildings, public buildings and commercial office blocks. The main purpose of photovoltaic panels is to generate electricity in an environmentally friendly way, by reducing the need to use conventional coal-fired power plants in Europe [25].

As an icon of sustainability and ecological transformation, photovoltaic panels are continually evolving, expanding their applications in various areas of social and economic life. Their flexibility and applications are becoming a source of inspiration for innovative solutions in energy, architecture, transport and everyday life. With technological progress and a growing understanding of the need to move towards sustainable energy sources, photovoltaic panels are finding wider use, contributing to reducing CO<sub>2</sub> emissions and our dependence on fossil fuels [8, 9].

The photovoltaic effect was discovered in 1839 by Alexandre Edmond Becquerel. In 1873 the effect was observed on selenium by Willoughby Smith, and in

1877 Adams and Day developed the first solar cell. Einstein's 1905 photoelectric theory and Russell Ohl's 1939 work on n-type and p-type regions in silicon were crucial to the development of photovoltaic technology. In 1955, solar energy was used to power a telecommunications network in Americus, Georgia (USA). NASA began to use photovoltaic technology in its projects, and the oil crisis in the 1970s accelerated the development of this technology. Solarex, founded in 1973, has contributed to the development of solar cells for public applications. New photovoltaic technologies have emerged, classified into different generations, and research in areas such as electronics, photonics and quantum mechanics has enabled improvements in photovoltaic cells, including flexible and painted cells. Improvements in the performance of the various cells have continued over the years, with photovoltaic technology also extending to other system components such as inverters, batteries and cables, which has contributed to its widespread use [9]. Photovoltaic panels are used in various areas. They are most commonly found on the roofs of single-family homes, businesses or farms.

\* Corresponding author: [piotr.stegenta@gmail.com](mailto:piotr.stegenta@gmail.com) (P. Stegenta)

## 2. Photovoltaic panels in rail vehicles

### 2.1. Green Railway Programme

One of the sectors included in the transformation is rail transport. The Green Railway programme developed by the Centre for Railway Energy Efficiency (CREE), which brings together rail industry stakeholders, envisages a change in the origin of traction electricity used by rail operators in Poland. Renewable energy sources (RES) are expected to provide 85% of energy in 2030, with a target transformation of 100% RES [20].

„The Green Railway Programme is an ambitious, comprehensive undertaking, part of the drive to reduce the carbon footprint of transport. Exploiting its potential means taking concrete action in favour of electromobility in our country” [20].

In countries such as the Netherlands and Austria, railways are already using RES, with energy coming from wind and solar power. EU policymakers and regulators have set a clear goal to achieve climate neutrality across the EU by 2050 [23, 29]. Established in December 2020. The Sustainable and Intelligent Mobility Strategy, of which the Green Deal is a part, indicates that journeys of less than 500 km should be climate-neutral in Europe by 2030. One way of applying RES in the rail sector is the use of photovoltaic panels on rail tracks. [26, 29].

### 2.2. Possibility of using photovoltaic panels to power passenger carriages

„Photovoltaic cells allow the energy from the sun's rays to be converted into electrical energy (direct current). The greatest advantages of using the sun's rays as an energy source are their free availability across the planet and their inexhaustibility. Using them does not adversely affect the climate or the Earth's energy balance” [25].

For this reason, the implementation of photovoltaic panels on the roofs of rail vehicles has been taking place for several years. Due to the construction of railway vehicles, such an application concerns:

- passenger carriages
- electric multiple units (EMU)
- diesel multiple units (DMU).

The energy obtained from the photovoltaic panels can be used to power among other things:

- the heating and air-conditioning system
- power supply for 24 V circuits on wagons
- lighting on the vehicles
- passenger information system.

For vehicles consisting of a locomotive and passenger carriages, this will reduce the electricity con-

sumption of the above-mentioned equipment from the overhead line.

For an EMU vehicle, this will work in a similar way, reducing the current drawn from the overhead contact line.

The photovoltaic installation increases the weight of the vehicle on which it is implemented. This results in an increase in the axle load of the wheelset. This can result in exceeding the assumed contact forces [3].

The implementation of photovoltaic panels on the roofs of rail vehicles should take place on routes where the region has enough sunlight for the solution to be used.

Figures 1 and 2 present the average direct insolation in spring and summer. It shows that in summer, in most of the country, the total insolation per horizontal surface reaches an average value of 200 W/ m<sup>2</sup> [27].

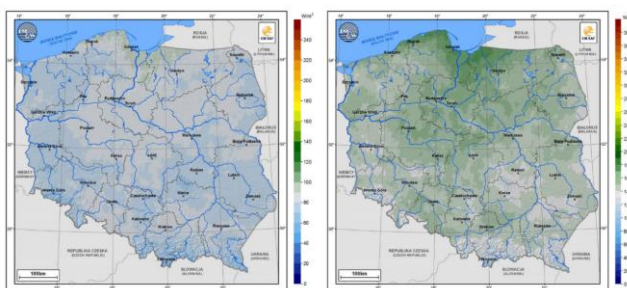

Fig. 1. Direct insolation during spring in Poland; left: horizontal surface, right: perpendicular surface [2]

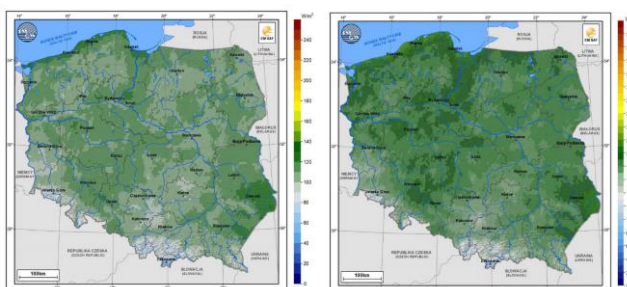

Fig. 2. Direct insolation during summer in Poland; left: per horizontal surface, right: perpendicular surface [2]

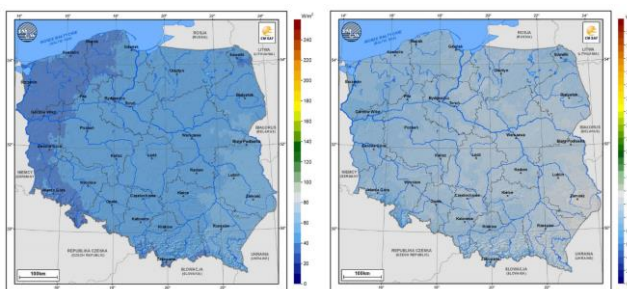

Fig. 3. Direct insolation during autumn in Poland; left: horizontal surface, right: perpendicular surface [2]

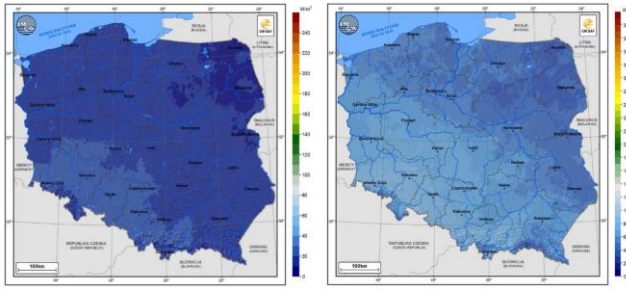

Fig. 4. Direct insolation during winter in Poland; left: horizontal surface, right: perpendicular surface [2]

Figures 3 and 4, on the other hand, show the average insolation in autumn and winter. They reveal that the weakest insolation occurs in autumn and winter and is around 30 W/m<sup>2</sup>. The total annual insolation in Poland is about 1000 W/m<sup>2</sup>. The insolation conditions in Poland allow the use of photovoltaic technology to generate electricity.

### 3. Review of photovoltaic panels for mounting on the roof of a passenger carriage

#### 3.1. Photovoltaic panel technology

Two types of photovoltaic panels dominate the market due to their manufacturing technology. Monocrystalline panels and polycrystalline panels. Table 1 provides an overview of the characteristics of photovoltaic panels.

Table 1. Overview of the characteristics of photovoltaic panels [18, 28]

	Monocrystalline panel	Polycrystalline panel
Efficiency	18–23%	14–16%
Utilisation of area	Due to the higher efficiency of monocrystalline panels, less panels are required to generate energy.	Polycrystalline panels typically require more surface area to meet energy demand than monocrystalline panels.
Temperature resistance	Monocrystalline panels show a slightly higher resistance to high temperatures than polycrystalline.	Weaker resistance to high temperatures, which means that the service life of the panel is reduced.
Esthetics	Monocrystalline panels take on a dark blue or black colour and are made up of cells with rounded corners.	Polycrystalline panels take on a blue colour – this is due to the presence of an anti-reflective coating on their surface. They consist of square cells.
Cost	High	Low

Monocrystalline panels are more efficient in obtaining power than polycrystalline panels, therefore they can take up less space on the carriage. This type of panels also have better efficiency in less sunlight conditions than polycrystalline panels. Due to their dark colour, monocrystalline modules are considered more aesthetically pleasing.

#### 3.2. Analysis of selected photovoltaic panels

Table 2 shows the basic technical data of the 609A passenger carriage.

Table 2. Basic technical data of the 609A wagon after modernisation [19]

Model	609A
Length of the wagon body [mm]	24200
Length of wagon with buffers [mm]	24500
Width of the wagon body [mm]	2883
Height of wagon from rail head [mm]	4050
Mass of the wagon [kg]	42000
Battery voltage [V]	24
Battery capacity [Ah]	450 Ah
Number of seats	32

Photovoltaic panels will be able to cover most of the roof area, leaving the necessary space for ventilation ducts and roof aerials [7, 21].

Due to the shape of the railway carriage and its vehicle gauge, the space in which photovoltaic panels can be used is limited. The main criterion for the selection of the panels was the nominal dimensions and mechanical design of the panel. Installation of all devices must meet the conditions for maintaining the gauge of the wagon and would allow trouble-free assembly or removal in the event of maintenance work. The panels were analysed in terms of the above parameters and a summary is shown in Table 3.

Table 3. Selected panel types and their characteristics for application on passenger carriages [13–17]

	Sol-farm panels 130W	Panels MAXX 100W	Panels 4SUN-170W	Panels MAXX 200W BF HC	4SUN-FLEX-ETFE-M 120W Prestige PCB
Panel length [mm]	540	540	1230	700	1120
Panel width [mm]	1160	1075	670	1410	600
Single panel peak power [W]	130	100	170	200	120
Cell efficiency [-]	0.21	0.21	0.20	0.22	0.22
Total number of panels in the x axis	19	20	16	15	11
Total number of panels in the y axis	2	2	2	2	2
Total number of panels	38	40	32	30	22
Total external area of panels [m <sup>2</sup> ]	23.56	23.22	26.37	29.61	14.78
Mass [kg]	361	244	268	330	60
Maximum instantaneous output power [kWp]	4.94	4	5.44	6	2.64



Preliminary analyses of the panels indicate that the Maxx 200W BF HC panels obtain the most energy from the sunlight, using as much roof area as possible while maintaining the wagon gauge.

Another area of the carriage that can be used for power generation are the walls of the wagon. After mechanical analyses and available instantaneous power analyses, a 4SUN-FLEX-ETFE 120W panel was selected. The parameters of the selected panels are shown in Table 4.

Table 4. Comparison of parameters for selected photovoltaic panels [14, 15]

	Panel MAXX 200W BF HC	4SUN-FLEX-ETFE-M 120W Prestige PCB
Length of the panel [mm]	700	1120
Width of the panel [mm]	1410	600
Total area of panels [m <sup>2</sup> ]	0.987	0.57
Mass [kg]	11	1.7
Maximum instantaneous output power STC [Wp]	200	120
Single panel peak power NOCT [Wp] (5.3)	159	112
Cell efficiency (5.1)	$\eta = 0.202$	$\eta = 0.21$
Voltage at maximum power point [V]	$V_{pm} = 18.1$ V	$V_{pm} = 19.5$ V
Current at maximum power point [A]	$I_M = 11.05$ A	$I_M = 6.15$ A
Short-circuit current of the cell [A]	$I_{sc} = 11.95$ A	$I_{sc} = 6.77$ A
Open circuit voltage [V]	$U_{oc} = 21.72$ V	$U_{oc} = 23.4$ V
Fill factor FF (5.1)	$FF = 0.77$	$FF = 0.75$
Panel class	A	A
Cell power loss factor [%/°C]	$\Upsilon = 0.4\%/^{\circ}\text{C}$	$\Upsilon = 0.4\%/^{\circ}\text{C}$

#### 4. Assembly of photovoltaic panels

The installation of the panels on the wagon depends on the available space and the condition that the panels do not interfere with the wagon gauge. The wagon gauge and available space defines the number of panels that can be mounted. Based on a simulation carried out using 3D design software, the monocrystalline panels were adapted to the above mounting conditions on the roof of the passenger carriage. The visualisation of a panels mounted on the wagon is shown as a 3D model in Fig. 5.

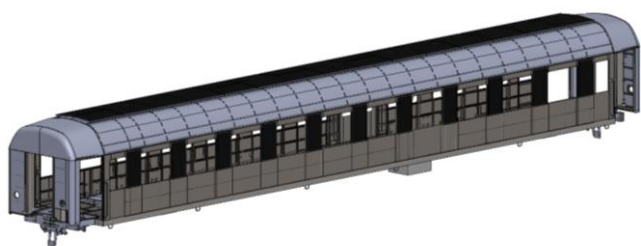

Fig. 5. 3D model of passenger carriage with mounted solar panels

Walls panels were placed between the windows on both sides. This provided the largest possible surface area for installation. All panels are mounted on racks, which provides a secure mechanical connection to the carriage, air circulation around the panel and also facilitates eventual servicing.

### 5. Power calculations

#### 5.1. Efficiency and fill factor calculations for solar cells

One of the basic criteria for evaluating the performance of a photovoltaic panel is its efficiency, Table 5 shows the calculations of this property for the two selected panels.

Table 5. Panels efficiency calculations

Calculations of efficiency of selected panels		
	Panel MAXX 200 W BF HC	4SUN-FLEX-ETFE-M 120 W Prestige
Voltage at maximum power point	$V_{pm} = 18.1$ V	$V_{pm} = 19.5$ V
Current at maximum power point	$I_M = 11.05$ A	$I_M = 6.15$ A
Panel surface area	$S = 0.987$ m <sup>2</sup>	$S = 0.57$ m <sup>2</sup>
Insolation under STC conditions (standard test conditions)	$E = 1000$ W/m <sup>2</sup>	$E = 1000$ W/m <sup>2</sup>
Efficiency [30]	$\eta = \frac{V_{pm} \cdot I_M}{S \cdot E} = 0.202$	$\eta = \frac{V_{pm} \cdot I_M}{S \cdot E} = 0.21$
Summary	$\eta = 0.202$	$\eta = 0.21$

Another important parameter is the fill factor (FF). The highest value of this factor is recommended, preferably specified in class A for photovoltaic panels. This is a coefficient that presents how similar the current-voltage characteristics of a photovoltaic cell are to the ideal characteristics. The theoretical characteristics have the form of a rectangular area defined by the short-circuit current of the cell and the open-circuit voltage [13]. The calculation of FF is shown in Table 6.

Table 6. Calculation of the fill factor FF

Calculation of the fill factor FF		
	Panel MAXX 200 W BF HC	4SUN-FLEX-ETFE-M 120W Prestige
Voltage at maximum power point	$V_{pm} = 18.1$ V	$V_{pm} = 19.5$ V
Current at maximum power point	$I_M = 11.05$ A	$I_M = 6.15$ A
Short-circuit current of the cell	$I_{sc} = 11.95$ A	$I_{sc} = 6.77$ A
Open circuit voltage	$U_{oc} = 21.72$ V	$U_{oc} = 23.4$ V
Fill factor FF [30]	$FF = \frac{V_{pm} \cdot I_M}{U_{oc} \cdot I_{sc}} = 0.77$	$FF = \frac{V_{pm} \cdot I_M}{U_{oc} \cdot I_{sc}} = 0.75$
Summary	$FF = 0.77$	$FF = 0.75$
Panel class	A	A

#### 5.2. Instantaneous output of panels

The calculation of the total power produced by photovoltaic panels is based on the summation of all

the instantaneous powers generated by individual panels during Standard Test Conditions (STC).

Number of panels installed on the roof:

$$n_{\text{panel\_roof}} = 30$$

Number of panels on the walls:

$$n_{\text{panel\_wall}} = 22$$

Instantaneous power of a single panel on the roof:

$$P_{\text{panel\_roof}} = 200 \text{ Wp}$$

Instantaneous power of a single wall panel:

$$P_{\text{panel\_wall}} = 120 \text{ Wp}$$

Total instantaneous power of all panels on the roof:

$$P_{\text{ROOF}} = P_{\text{panel\_roof}} \cdot n_{\text{panel\_roof}} = 200 \cdot 30 = 6 \text{ kWp} \quad (1)$$

Total instantaneous power of all panels on the carriage walls:

$$P_{\text{WALL}} = P_{\text{panel\_wall}} \cdot n_{\text{panel\_wall}} = 120 \cdot 22 = 2.64 \text{ kWp} \quad (2)$$

Total instantaneous power of all panels on the wagon:

$$P_{\text{PANEL p-p}} = P_{\text{ROOF}} + P_{\text{WALL}} = 6 + 2.64 = 8.64 \text{ kWp} \quad (3)$$

Summing up the peak power of all the installed photovoltaic panels on the wagon, the available power equals 8.64 kWp. This is an instantaneous power that can only be obtained under laboratory conditions, which is practically never achievable. This is due to the different levels of insolation during the day, the different direction of the moving trainset and the way the panels are mounted on the wagon.

### 5.3. Power losses

In addition, the power of a single panel under Normal Operating Target Temperature (NOCT) conditions should be taken into account. NOCT are close to real conditions and are characterised by the parameters [11]:

- Insolation = 800 W/m<sup>2</sup>
- Panel ambient temperature = 20°C
- Wind velocity = 1 m/s.

Table 7 shows the calculation of the power loss taking into account the NOCT factor.

The position of the panels in relation to the sun has a major impact on their efficiency. Table 8 shows the correction factors according to the orientation of the panels in relation to the north direction:

- 90° arrangement of panels on carriage walls
- 15° arrangement of panels on carriage roof.

Table 7. Calculation of loss factor, taking into account NOCT conditions

	Panel MAXX 200W BF HC	4SUN-FLEX-ETFE-M 120W Prestige PCB
Power of a single panel under ideal STC conditions	200 Wp	120 Wp
Panel surface area	P = 0.987 m <sup>2</sup>	P = 0.672 m <sup>2</sup>
Efficiency	$\eta = 0.2$	$\eta = 0.21$
Real power obtained under NOCT conditions	NOCT · P · $\eta = 800 \cdot 0.987 \cdot 0.2 = 159 \text{ Wp}$	NOCT · P · $\eta = 800 \cdot 0.672 \cdot 0.21 = 112 \text{ Wp}$
Loss ratio in relation to ideal values STC	$\eta_{\text{roof}} = 0.79$	$\eta_{\text{wall}} = 0.93$

Table 8. Panel efficiency due to angle of panel placement [12]

Panel efficiency due to angle of panel placement								
Direction	East		South-East			South		
Angle in relation to north	90	105	120	135	150	165	180	195
Roof – 15°	90	91	93	94	95	95	96	95
Wall – 90°	90	91	93	94	95	95	96	95
Summary								
Mean efficiency of panels on roof						93.07%, $\eta_{\text{roof\_angle}} = 0.930$		
Mean efficiency of panels on walls						65.69% $\eta_{\text{wall\_angle}} = 0.656$		

Calculations of instantaneous power of all panels on the roof taking into account NOCT conditions and angle of orientation:

$$P_{\text{ROOF}} = P_{\text{panel\_roof}} \cdot n_{\text{panel\_roof}} \cdot \eta_{\text{roof}} \cdot \eta_{\text{roof\_angle}} = 200 \cdot 30 \cdot 0.79 \cdot 0.93 = 4.408 \text{ kWp} \quad (4)$$

Calculation of instantaneous power of all panels on the wagon walls after taking into account NOCT conditions and angle of arrangement:

$$P_{\text{WALL}} = P_{\text{panel\_wall}} \cdot n_{\text{panel\_wall}} \cdot \eta_{\text{wall}} \cdot \eta_{\text{wall\_angle}} = 120 \cdot 22 \cdot 0.93 \cdot 0.656 = 1.610 \text{ kWp} \quad (5)$$

Calculations instantaneous power of all panels considered on the carriage:

$$P_{\text{PANEL p-p}} = P_{\text{ROOF}} + P_{\text{WALL}} = 4.408 + 1.610 = 6.008 \text{ kWp} \quad (6)$$

An important aspect of wagon modernisation planning is the consideration of losses caused by the cables, inverter, bypass diodes. These are related to the current-voltage mismatch. In order to determine the level of all losses, the data in Table 9 was used for the calculations.

Table 9. Total energy loss of a photovoltaic system [5, 28]

Type of loss	Description	Value
Cable loss	Should not be greater than 1%. If the calculation comes out higher than 1%, the cross-section of the wires should be increased.	1%
Inverter loss	Assumed inverter efficiency of 94%	6%
PV loss caused by temperature	As the ambient temperature increases, panel losses rise $T_{cell} = T_{ambient} + \frac{(NOCT-20) \times E}{800} = 65^{\circ}C$ Assumed in the calculation: $T_{ambient} = 40^{\circ}C$ NOCT – 45°C nominal temperature under real conditions E – insolation Cell power loss ratio $\gamma = 0.4\%/^{\circ}C$ $(T_{cell} - NOCT) \times \gamma = 8\%$	8%
Bypass diode loss	Protection against panel voltage fluctuations	0.5%
Losses due to current mismatch of photovoltaic modules	Losses caused by differences in current-voltage characteristics of the modules used	1.5%
Panel wear loss	Losses after the first year of use	3%
Summary	The total loss is	20%
Summary	The efficiency ratio is	0.8

5.4. Real energy gain

In order to determine the annual energy production from the panels, the energy gain must be calculated. The average insolation occurring in Poland needs to be determined. The solar map of Poland shown in Fig. 7 was used for this purpose.

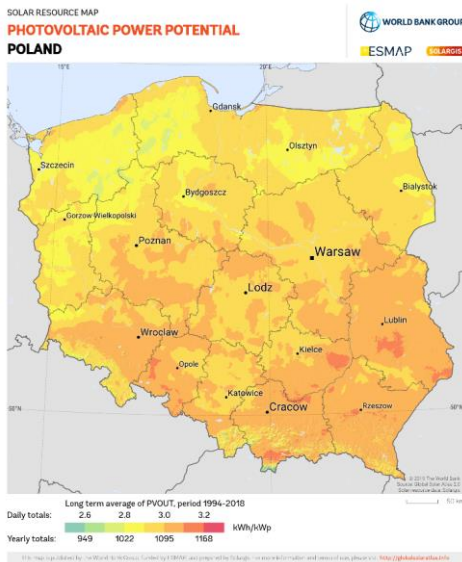

Fig. 7. Solar map of Poland [24]

On the basis of the above map, it was determined that the annual density of sunlight in Poland per horizontal plane varies between 950–1250 kWh/m².

Energy gain:

$$E_{yg} = \frac{P_{PANEL\ p-p} \cdot I \cdot W_w}{STC} = \frac{6.008 \times 1050 \times 0.8}{1} = 5046 \text{ kWh/year} \quad (7)$$

where:  $E_{yg}$  [kW] – energy gain throughout the year,  $I$  [kWh/m²] – insolation, for Polish conditions the average annual insolation equals 1050 kWh/m²,  $W_w$  – efficiency ratio of modules.

Average energy gain per month and day:

$$E_{month} = \frac{7257}{12} = 420.56 \text{ kWh/month} \quad (8)$$

$$E_{day} = \frac{604.75}{30} = 14.01 \text{ kWh/day} \quad (9)$$

Further analysis should consider exactly in which months in Poland the conditions are the best for obtaining energy from solar panels. According to 2.2, in Poland it can be obtained in spring and summer.

Based on solar maps, the average distribution of insolation in Poland in the individual months was plotted on a graph (Fig. 8).

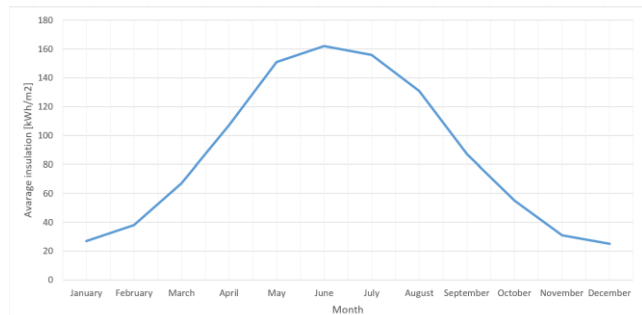

Fig. 8. Average insolation in Poland by month [25, 28]

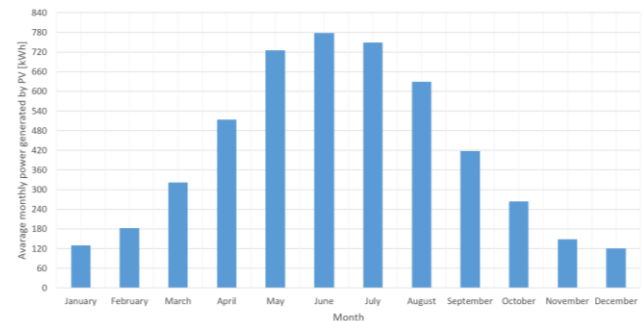

Fig. 9. Average output of photovoltaic panels in Poland by month

Approximately 80% of the total annual solar insolation falls during the six months of the spring-summer season, from the beginning of April to the end of September. The solar operation time in summer increases to 16 hrs/day, while in winter it decreases to 8 hrs/day. Figures 9 and 10 show what average power can be obtained on a monthly and daily based on data from energy gain calculations (7) and data from the average insolation in Poland [25].

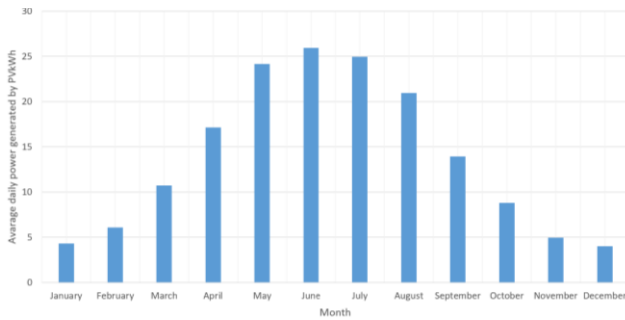

Fig. 10. Average daily output of photovoltaic panels in Poland by month

Taking into account that the train will travel in different regions of Poland and in various directions, it is not always possible to obtain the approximate theoretical output shown above from photovoltaic panels. Solar exposure is not the same across the Poland. Higher insolation coefficients are found in the south-east and lower in the north. Depending on the direction of the trainset, some photovoltaic panels may not get enough sunlight. Table 10 summarises the monthly and daily energy gain, taking into account all discussed power losses.

Table 10. Summary of monthly and daily energy gains [10, 20]

	Insolation [W/m <sup>2</sup> ]	Monthly energy gain [kWh]	Daily energy gain [kWh]
January	27	129.6864	4.32288
February	38	182.5216	6.084053
March	67	321.8144	10.72715
April	107	513.9424	17.13141
May	151	725.2832	24.17611
June	162	778.1184	25.93728
July	156	749.2992	24.97664
August	131	629.2192	20.97397
September	87	417.8784	13.92928
October	55	264.176	8.805867
November	31	148.8992	4.963307
December	25	120.08	4.002667

## 6. Energy storage

Among the batteries available on the market for storing energy from photovoltaic installations, LiFePO<sub>4</sub> batteries are recommended. The LiFePO<sub>4</sub> is a type of high-power lithium-ion battery, or more precisely a lithium-iron-phosphate.

Key features of LiFePO<sub>4</sub> batteries include:

- long service life – they are distinguished above all by their extremely long service life, with up to 3000 cycles
- high capacity – they have an impressive capacity and provide more power output, while maintaining a smaller size and lower weight
- low self-discharge – no need for regular recharging and 100% current guaranteed, regardless of the level of discharge

- no memory effect – not affected by partial discharge or incomplete charging, no loss of nominal capacity and a constant number of charge cycles
- fast charging process – possibility to top up at fast charging stations
- ready for any weather – they are extremely durable, making them ideal for use even in difficult outdoor conditions such as high or low temperatures [1].

Based on the average daily power gain data from the panels and the physical and chemical parameters of the LiFePO<sub>4</sub> battery, capacity calculations were performed, as shown in Table 11 [4, 22].

Table 11. Battery capacity calculations

Average daily gain	14 kWh
Battery voltage	48 V
Battery capacity	$W_{\text{battery}} = \frac{14 \text{ kWh}}{48} = 291 \text{ Ah}$
Monthly self-discharge of batteries LiFePO <sub>4</sub> – 3% [5]	8.75 Ah
Summary	$W_{\text{battery}} = 300 \text{ Ah}$ $P_{\text{battery}} = 14.4 \text{ kWh}$

## 7. Systems powered by photovoltaic panels

During the winter, the photovoltaic installation can supply energy to e.g. passenger information boards – external, which require a power of around 400 W.

In the summer, the photovoltaic installation will be able to supply power to the passenger information boards – outdoor (400 W) and indoor (420 W), as well as to the GSM/LTE signal booster (780 W).

Additionally, during the period of peak insolation throughout the year, consideration may be given to supplying electricity to the air-conditioning system, whose electrical output in cooling mode is 25.4 kW. It is possible to set the air conditioner in 4 power consumption modes 25%, 50%, 75%, 100%. Considering the smallest percentage of power consumption, we obtain a continuous power of 6.35 kW at 25%. Table 12 shows the possibility of using energy storage depending on the chosen carriage systems.

Table 12. Examples of wagon circuits that can be supplied by energy storage

Device	Power consumption	Available energy storage	Operating time
Passenger information boards – external	400 W	14.4 kWh	36 h
Passenger information boards – internal	420 W	14.4 kWh	34 h
GSM/LTE signal amplifier	780 W	14.4 kWh	18 h
Emergency lighting	250 W	14.4 kWh	57 h
Air conditioner total power 24.4 kW	6.35 kW (25% of total power)	14.4 kWh	2.26 h

Based on the power demand and the energy gain (Table 10), it can be concluded that the period from May to September is the most appropriate to use the photovoltaic panels energy storage to power the air conditioner (assuming that the lowest power consumption mode is used). The other components outlined above should work properly all year round using solar energy.

### 8. Topology of photovoltaic installations

Three basic photovoltaic installations can be distinguished:

*On-grid photovoltaics* is a networked, grid-connected installation. The purpose of this installation is to generate energy from photovoltaic panels and transmit it to the grid. This type is characterised by a lack of energy storage.

*Off-grid photovoltaics*, which means not connected to the electricity grid. It is an independent installation from the external power network. Its purpose is to store energy via photovoltaic panels.

*Hybrid photovoltaics* is a grid topology combining features of the two installations, on-grid and off-grid. This is an installation that integrates the management of energy from different sources such as solar panels, the electricity grid, batteries. The system is capable of operating in “on-grid” mode, which allows the batteries to be charged from the external source if necessary. In the case of “off-grid” operation, where the external power grid is disconnected, the batteries are charged exclusively via solar panels.

The hybrid installation manages the charging and discharging of the batteries, which increases their life and energy storage efficiency [6].

The most reasonable photovoltaic grid topology that can be applied to passenger carriages is a hybrid installation. This is due to the great possibilities of configuration and energy management. Figure 11 shows a block diagram of a hybrid photovoltaic system.

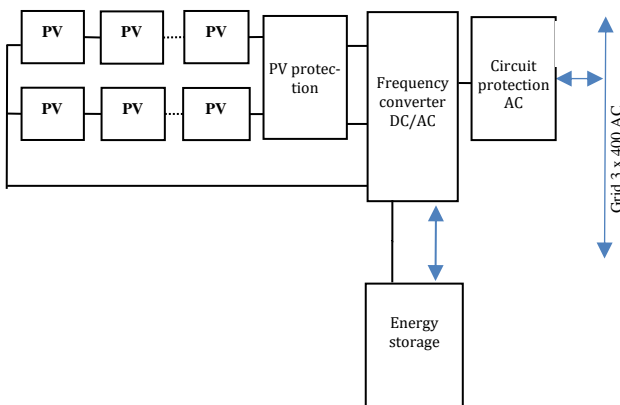

Fig. 11. Hybrid system block diagram

### 9. Comparison of electrical and mechanical parameters

Table 13 shows all mechanical and electrical parameters.

Table 13. Summary of electrical and mechanical parameters

Summary of parameters	
Panel surface area	
Panels area on the roof	29.61 m <sup>2</sup>
Panels area on the wall	14.78 m <sup>2</sup>
Total surface area of panels	44.39 m <sup>2</sup>
Mass	
Mass of panels on the roof	330 kg
Mass of panels on the walls	100 kg
Battery mass	150 kg
Weight of electrotechnical equipment	200 kg
Total mass	780 kg
Photovoltaic panels	
Applied photovoltaic panels	monocrystalline
Number of panels on the roof	30
Number of panels on the walls	22
Class of panels	A
Panel efficiency	0.2; 0.21
Power	
Theoretical total power	8.64 kWp
Real total output from the photovoltaic system	4.8 kW
Loss ratio	0.55
Energy gains	
Average annual energy gain	5046 kWh
Average monthly energy gain	420 kWh
Average daily energy gain	14 kWh
Average summer energy gain (May-August)	
Average daily summer energy gain	720 kWh
Average daily summer energy gain	24 kWh
Average winter energy gain (November-February)	
Average daily energy gain in winter	144 kWh
Average energy gain in spring-autumn (March, April, September, October)	4.8 kWh
Average daily spring-summer energy gain	378 kWh
Average daily spring-summer energy gain	12 kWh
Energy storage	
Battery capacity	300 Ah
Battery voltage	48 V
Battery type	LiFePO <sub>4</sub>

### Conclusions

Photovoltaic panels will generate more and more electricity every year due to the implementation of the European Green Deal programme. The use of photovoltaic panels on railway carriages appears to be the next step in Poland's energy transition. The Green Railway programme, which is one of the objectives set by the European Union, is to achieve almost total use of electricity from RES. For the rail sector, this presents a challenge, as previous trends have not dictated the need to construct vehicles capable of autonomous energy capture. As a country located in a temperate climate zone, Poland has the possibility of using solar energy. Calculations have shown that covering the roof and walls of a passenger wagon with solar



panels can provide an average daily energy production of around 14 kWh. The Sustainable and Smart Mobility Strategy, of which the Green Deal is a part, indicates that journeys of less than 500 km should be cli-

mate-neutral in Europe by 2030. The above considerations lead to the following conclusion: the use of trainset roofs for the installation of photovoltaic panels is reasonable.

## Bibliography

- [1] Akumulatory LiFePO<sub>4</sub>. Kon-tec. 2024. <https://kon-tec.eu/produkty/akumulatory-lifepo4> (accessed on 1.10.2024).
- [2] Atlas warunków solarnych. Klimat Polski – serwis IMG-PIB (in Polish). 2024. <https://klimat.imgw.pl/pl/solar-atlas/> (accessed on 1.10.2024).
- [3] Chen Z, Jiang M, Qi L, Wei W, Yu Z, Wei W et al. Using existing infrastructures of high-speed railways for photovoltaic electricity generation. *Resources, Conservation and Recycling*. 2022;178:106091. <https://doi.org/10.1016/j.resconrec.2021.106091>
- [4] Daszkiewicz P, Kołodziejek D. Comparison and analysis of modern combustion powertrain systems of rail vehicles. *Combustion Engines*. 2024;196(1):46-53. <https://doi.org/10.19206/CE-171385>
- [5] Filipiak M, Nowrowski R, Kurz D, Pierzchała R. Analiza opłacalności instalacji fotowoltaicznej we współpracy z magazynem energii dla domu jednorodzinne (in Polish). *Przegląd Elektrotechniczny*. 2022;11. <https://doi.org/10.15199/48.2022.11.52>
- [6] Instalacja on-grid, off-grid, czy hybrydowa? Porównanie (in Polish). Erato Energy. 2024. <https://www.eratoenergy.pl/instalacja-on-grid-off-grid-czy-hybrydowa-porownanie/> (accessed on 1.10.2024).
- [7] Jagielski A, Ziółkowski A, Bednarek M, Siedlecki M. Empirical evaluation of the replacement of conventionally powered vehicles with hybrid and electric vehicles on the example of the Poznan agglomeration. *Energies*. 2024;17(21):5247. <https://doi.org/10.3390/en17215247>
- [8] Małek A, Dudziak A, Stopka O, Caban J, Marciniak A, Rybicka I. Charging electric vehicles from photovoltaic systems – statistical analyses of the small photovoltaic farm operation. *Energies*. 2022;15(6):2137. <https://doi.org/10.3390/en15062137>
- [9] Marques Lameirinhas RA, Torres, JPN, de Melo Cunha JP. A photovoltaic technology review: History, fundamentals and applications. *Energies*. 2022;15(5):1823. <https://doi.org/10.3390/en15051823>
- [10] Nasłonecznienie w Polsce – analiza i wpływ na działanie fotowoltaiki (in Polish). Sunlife. 2024. <https://sunlifefotowoltaika.pl/wpis/naslonecznienie-w-polsce-analiza-i-wplyw-na-dzialanie-fotowoltaiki> (accessed on 1.10.2024).
- [11] Nominal operating cell temperature. PVEducation. 2024. <https://www.pveducation.org/pvc/drom/modules-and-arrays/nominal-operating-cell-temperature> (accessed on 1.10.2024).
- [12] Optymalne ustawienie paneli fotowoltaicznych (in Polish). Fotowoltaika premium. 2024. <https://fotowoltaikapremium.info.pl/ustawienie-paneli-fotowoltaicznych/> (accessed on 1.10.2024).
- [13] Panel fotowoltaiczny 100W MAXX (in Polish). 4sun. 2024. <https://www.4sun.eu/baterie-sloneczne-monokrystaliczne/panel-fotowoltaiczny-100w-maxx> (accessed on 1.10.2024).
- [14] Panel fotowoltaiczny 200W MAXX BFHC (in Polish). 4sun. 2024. <https://www.4sun.eu/panele-sloneczne/panel-fotowoltaiczny-200w-maxx-bf-hc> (accessed on 1.10.2024).
- [15] Panel fotowoltaiczny (in Polish). 4sun-flex-efte-m 120W prestige PCB. 4sun. 2024. <https://www.4sun.eu/panele-elastyczne-flex/panel-elastyczny-4sun-flex-efte-m-120w-prestige-pcb> (accessed on 1.10.2024).
- [16] Panel słoneczny Solarfam 130 W monokrystaliczny (in Polish). Ekowolt. 2024. <https://ekowolt.pl/4351/panel-sloneczny-130w-monokrystaliczny> (accessed on 1.10.2024).
- [17] Panel solarny monokrystaliczny 170 W (in Polish). 4sun. 2024. <https://www.4sun.eu/baterie-sloneczne-monokrystaliczne/panel-solarny-monokrystaliczny-170w> (accessed on 1.10.2024).
- [18] Panele monokrystaliczne a polikrystaliczne – różnice (in Polish). Corab. 2021. <https://corab.pl/aktualnosci/panele-fotowoltaiczne-monokrystaliczne-a-polikrystaliczne-roznice> (accessed on 1.10.2024).
- [19] Panele słoneczne – monokrystaliczne czy polikrystaliczne: które lepsze? (in Polish). Trendy w energetyce. 2021. <https://trendywenergetyce.pl/panele-sloneczne-monokrystaliczne-czy-polikrystaliczne-ktore-lepsze-2> (accessed on 1.10.2024).
- [20] Photovoltaic geographical information system. European Commission. 2024. [https://re.jrc.ec.europa.eu/pvg\\_tools/en/](https://re.jrc.ec.europa.eu/pvg_tools/en/) (accessed on 1.10.2024).
- [21] Pielecha I, Cieślík W, Szwajca F. Energy flow and electric drive mode efficiency evaluation of different generations of hybrid vehicles under diversified urban traffic conditions. *Energies*. 2023;16(2):794. <https://doi.org/10.3390/en16020794>
- [22] Pielecha I. Modeling of fuel cells characteristics in relation to real driving conditions of FCHEV vehicles. *Energies*. 2022;15(18):6753. <https://doi.org/10.3390/en15186753>
- [23] Skrúcaný T, Kendra M, Čechovič T, Majerník F, Pečman J. Assessing the energy intensity and greenhouse gas emissions of the traffic services in a select-

- ed region. LOGI – Scientific Journal on Transport and Logistics. 2021;12(1):26-35.  
<https://doi.org/10.2478/logi-2021-0003>
- [24] Solar resource maps & GIS data. Solargis. 2024.  
<https://solargis.com/maps-and-gis-data/download/Poland> (accessed on 1.10.2024).
- [25] Swaldek K, Zawadzka D. Ocena możliwości zastosowania paneli fotowoltaicznych do zasilania wagonów pasażerskich (in Polish). V Ogólnopolska Konferencja Naukowo-Techniczna: Transport Kolejowy: Przeszłość – Teraźniejszość – Przyszłość. 2022.
- [26] Tian L, Huang Y, Liu S, Sun S, Deng J, Zhao H. Application of photovoltaic power generation in rail transit power supply system under the background of energy low carbon transformation. Alexandria Engineering Journal. 2021;60(6):5167-5174.  
<https://doi.org/10.1016/j.aej.2021.04.008>
- [27] Vasisht MS, Vashista GA, Srinivasan J, Ramasesha SK. Rail coaches with rooftop solar photovoltaic systems: a feasibility study. Energy. 2017;118:684-691.  
<https://doi.org/10.1016/j.energy.2016.10.103>
- [28] Wagony o typie 609A/611A/612A. Baza wagonów kolejowych (in Polish). 2024.  
<https://bazawagonow.pl/609a> (accessed on 1.10.2024).
- [29] Wyszowski K. UN Global Compact Network Poland. Zielona Kolej w Polsce – klimat, energetyka, transport. 25.10.2021.
- [30] Wyznaczenie współczynnika FF i określanie sprawności ogniwa fotowoltaicznego (in Polish). BIO-ecology. 2021.  
<https://www.bio-ecology.com.pl/wyznaczenie-wspolczynnika-ff-i-okreslanie-sprawnosci-ogniwa-fotowoltaicznego/> (accessed on 1.10.2024).